













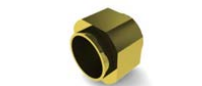
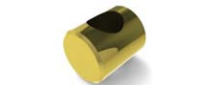

# Autoflex™ VI-RE Replacement Parts

Suggested Items to Stock

Part		Suggested Qty.
		Percentage of Total Qty. Needed
<input type="checkbox"/> Autoflex Cartridge Heaters with Braided Wires		10%
<input type="checkbox"/> Autoflex Cartridge Heater Male Side Plug (Heaters Not Included) (Typical 2 Heaters Go to Each Plug)		5%
<input type="checkbox"/> Adjuster Nut Retainers		10%
<input type="checkbox"/> Adjuster Nut Retainer Screw		100%
<input type="checkbox"/> Retainer Bridge		10%
<input type="checkbox"/> Lip Adjusting Bolts		25%
<input type="checkbox"/> Lip Adjusting Nuts		35%
<input type="checkbox"/> Lip Adjusting Inserts		35%
<input type="checkbox"/> Roll of Safety Wire		1
<input type="checkbox"/> Autoflex Blower – Filter (If blower was sold with the die)		100%
<input type="checkbox"/> Autoflex VI-RE Frame (Front and Rear) (Quantity May Depend on Number of Positions)		5% of Each & of Each Position
<input type="checkbox"/> Rod Mounting Bolt		100%
<input type="checkbox"/> Autoflex Translator Block		5%
<input type="checkbox"/> Push-Pull Adjustment Rod *The push-only adjustment rod is the same		5%
<input type="checkbox"/> Mounting Bar (Quantity May Depend on Number of Positions)		Minimum of 2 Of Each Position
<input type="checkbox"/> Optional Complete Autoflex VI-RE Modular System (Quantity May Depend on Number of Positions)		Minimum of 2 Of Each Position

# Autoflex™ VI-RE Replacement Parts

Suggested Items to Stock

## For Push-Only Autoflex

Lip Adjusting Block Bolts



100%

Retainer Bar Bolts

\*Also needed for all dual and triple manifold dies



100%

## For Dual/Triple Multi-Manifold Dies (Autoflex will need to be removed to open the die)

Autoflex VI-RE Mounting Block Bolts



100%

Lip Adjusting Block Bolts (Push-Pull and Push-Only)



100%

To order Autoflex VI-RE replacement parts, please contact us at [spareparts@nordson.com](mailto:spareparts@nordson.com).

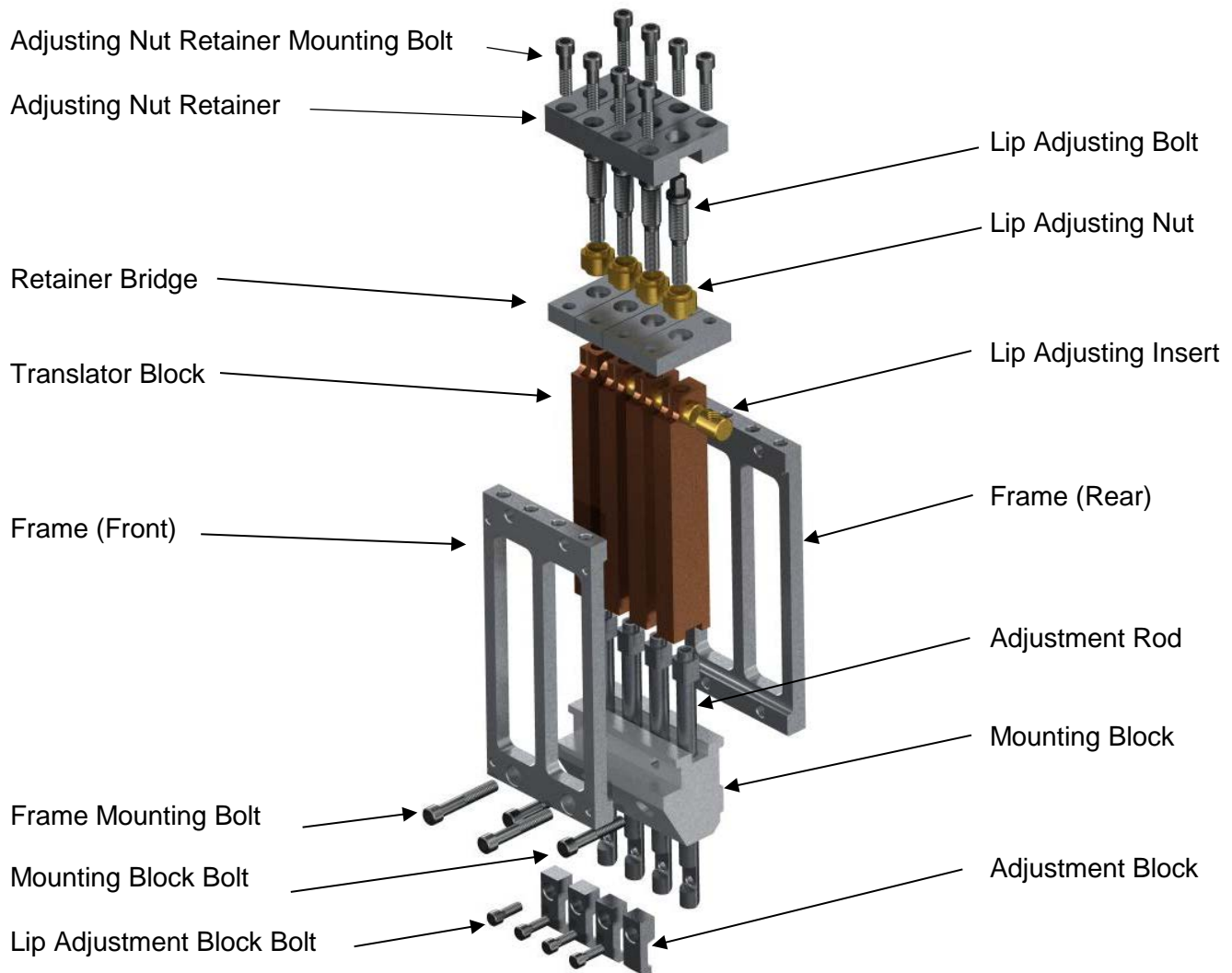

# Autoflex™ VI-RE Replacement Parts

Suggested Items to Stock

To order Autoflex VI-RE replacement parts, please contact us at [spareparts@nordson.com](mailto:spareparts@nordson.com)

